



Figure can vary

Part no.: 68090409
MLC300T40-900
Safety light curtain transmitter



Contents

- Technical data
- Suitable receivers
- Dimensioned drawings
- Electrical connection
- Circuit diagrams
- Operation and display
- Part number code
- Accessories
- Notes

Part no.: 68090409 – MLC300T40-900 – Safety light curtain transmitter

Technical data

Basic data	
Series	MLC 300
Device type	Transmitter
Contains	2x BT-NC sliding block
Application	Access guarding Hand protection Danger zone guarding
Functions	
Functions	Range reduction Transmission channel changeover
Characteristic parameters	
Type	2, IEC/EN 61496
SIL	1, IEC 61508
SILCL	1, IEC/EN 62061
Mission time T_M	20 years, EN ISO 13849-1
Protective field data	
Resolution	40 mm
Protective field height	900 mm
Operating range	0 ... 20 m
Optical data	
Synchronization	Optical between transmitter and receiver
Light source	LED, Infrared
LED light wavelength	940 nm
Transmitted-signal shape	Pulsed
LED group	Exempt group in acc. with EN 62471:2008
Electrical data	
Protective circuit	Overvoltage protection Short circuit protected
Performance data	
Supply voltage	24 V, DC, -20 ... 20 %
Current consumption, max.	50 mA
Fuse	2 A semi time-lag
Inputs	
Number of digital switching inputs	1 Piece(s)
Switching inputs	
Type	Digital switching input
Switching voltage high, min.	18 V
Switching voltage low, max.	2.5 V
Switching voltage, typ.	22.5 V
Voltage type	DC
Connection	
Number of connections	1 Piece(s)

Part no.: 68090409 – MLC300T40-900 – Safety light curtain transmitter
Connection 1

Type of connection	Connector
Function	Machine interface
Thread size	M12
Material	Metal
No. of pins	5 -pin

Cable properties

Permissible conductor cross section, typ.	0.25 mm ²
Length of connection cable, max.	100 m
Permissible cable resistance to load, max.	200 Ω

Mechanical data

Dimension (W x H x L)	29 mm x 966 mm x 35.4 mm
Housing material	Metal, Aluminum
Lens cover material	Plastic / PMMA
Material of end caps	Diecast zinc
Net weight	1,050 g
Housing color	Yellow, RAL 1021
Type of fastening	Swivel mount Groove mounting Mounting on Device Column Mounting bracket

Operation and display

Type of display	LED
Number of LEDs	2 Piece(s)

Environmental data

Ambient temperature, operation	0 ... 55 °C
Ambient temperature, storage	-30 ... 70 °C
Relative humidity (non-condensing)	0 ... 95 %



Certifications

Degree of protection	IP 65
Protection class	III
Certifications	c TÜV NRTL US TÜV Süd c CSA US
Vibration resistance	50 m/s ²
Shock resistance	100 m/s ²
US patents	US 6,418,546 B

Classification

eCl@ss 8.0	27272704
eCl@ss 9.0	27272704
ETIM 5.0	EC002549

Suitable receivers

	Part no.	Designation	Article	Description
	68091409	MLC310R40-900	Safety light curtain receiver	Resolution: 40 mm Protective field height: 900 mm Response time: 9 ms Connection: Connector, M12, Metal, 5 -pin Function package: Basic
	68092409	MLC320R40-900	Safety light curtain receiver	Resolution: 40 mm Protective field height: 900 mm Response time: 9 ms Connection: Connector, M12, Metal, 8 -pin Function package: Standard

Dimensioned drawings

All dimensions in millimeters

Calculation of the effective protective field height $H_{PFE} = H_{PFN} + B + C$

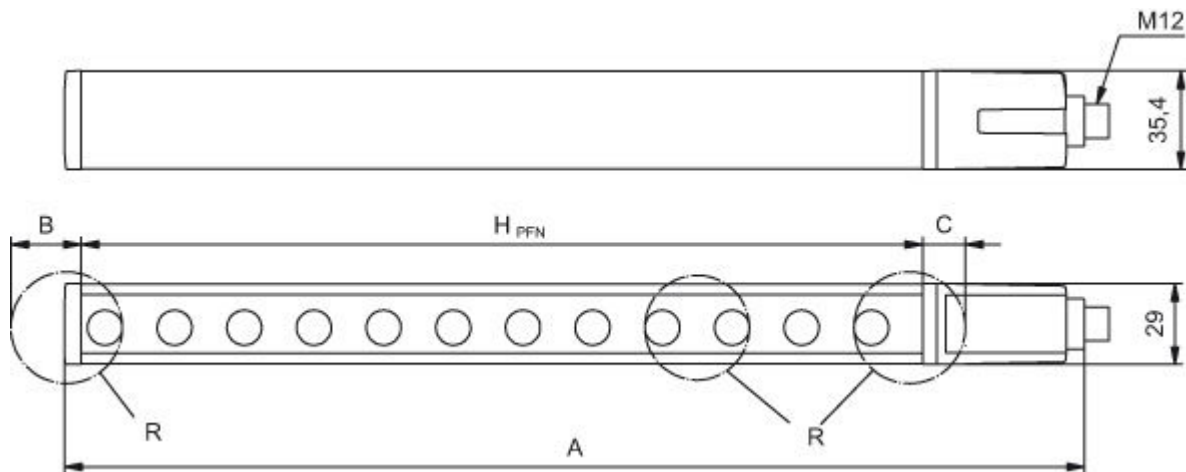

- HPFE Effective protective field height = 940 mm
- HPFN Nominal protective field height = 900 mm
- A Total height = 966 mm
- B 25 mm
- C 15 mm
- R Effective protective field height H_{PFE} goes beyond the dimensions of the optics area to the outer borders of the circles labeled with R.

Electrical connection

Connection 1	
Type of connection	Connector
Function	Machine interface
Thread size	M12
Type	Male
Material	Metal

Part no.: 68090409 – MLC300T40-900 – Safety light curtain transmitter

Connection 1	
No. of pins	5 -pin
Encoding	A-coded
Connector housing	FE/SHIELD

Pin	Pin assignment	Conductor color
1	VIN1	Brown
2	n.c.	White
3	VIN2	Blue
4	RNG	Black
5	FE/SHIELD	Gray

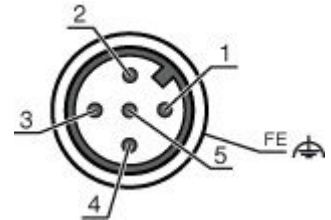

Circuit diagrams

Transmission channel C1, reduced range

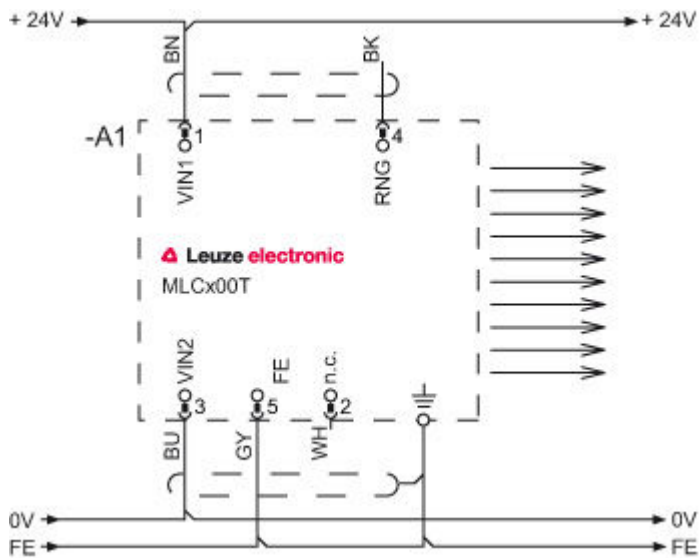

- 1 VIN1 = +24 V
- 3 VIN2 = 0 V
- 4 RNG = 0 V or open

Transmission channel C1, standard range



- 1 VIN1 = +24 V
- 3 VIN2 = 0 V
- 4 RNG = +24 V

Transmission channel C2, reduced range



- 1 VIN1 = 0 V
- 3 VIN2 = +24 V
- 4 RNG = 0 V or open

Transmission channel C2, standard range



- 1 VIN1 = 0 V
- 3 VIN2 = +24 V
- 4 RNG = +24 V

Operation and display

LEDs

LED	Display	Meaning
1	Off	Device switched off
	Red, continuous light	Device error
	Green, continuous light	Normal operation
2	Green, flashing	Reduced range selected by the wiring of pin 4
	Off	Transmission channel C1
	Green, continuous light	Transmission channel C2

Part number code

Part designation: MLCxyy-za-hhhhei-ooo

MLC	Safety light curtain
x	Series: 3: MLC 300 5: MLC 500
yy	Function classes: 00: Transmitter 01: transmitter (AIDA) 02: Transmitter with test input 10: Basic receiver - automatic restart 11: basic receiver - automatic restart (AIDA) 20: Standard receiver - EDM/RES selectable 30: Extended receiver - blanking/muting
z	Device type: T: transmitter R: receiver

Part no.: 68090409 – MLC300T40-900 – Safety light curtain transmitter





MLC	Safety light curtain
a	Resolution: 14: 14 mm 20: 20 mm 30: 30 mm 40: 40 mm 90: 90 mm
hhh	Protective field height: 150 ... 3000: from 150 mm to 3000 mm
e	Host/Guest (optional): H: Host MG: Middle Guest G: Guest
i	Interface (optional): /A: AS-i
ooo	Option: /V: high Vibration-proof EX2: explosion protection (zones 2 + 22) SPG: Smart Process Gating

Note



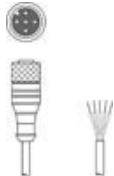

A list with all available device types can be found on the Leuze electronic website at www.leuze.com.

Accessories

Connection technology - Connection cables

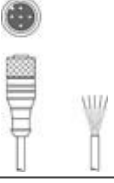
	Part no.	Designation	Article	Description
	429088	CB-M12-15000-5GF	Connection cable	Connection 1: Connector, M12, Axial, Female, A-coded, 5 -pin Connection 2: Open end Shielded: No Cable length: 15,000 mm Sheathing material: PUR
	678057	CB-M12-15000E-5GF	Connection cable	Connection 1: Connector, M12, Axial, Female, A-coded, 5 -pin Connection 2: Open end Shielded: Yes Cable length: 15,000 mm Sheathing material: PUR
	429089	CB-M12-25000-5GF	Connection cable	Connection 1: Connector, M12, Axial, Female, A-coded, 5 -pin Connection 2: Open end Shielded: No Cable length: 25,000 mm Sheathing material: PUR
	678058	CB-M12-25000E-5GF	Connection cable	Connection 1: Connector, M12, Axial, Female, A-coded, 5 -pin Connection 2: Open end Shielded: Yes Cable length: 25,000 mm Sheathing material: PUR
	429281	CB-M12-50000-5GF	Connection cable	Connection 1: Connector, M12, Axial, Female, A-coded, 5 -pin Connection 2: Open end Shielded: No Cable length: 50,000 mm Sheathing material: PUR



Part no.: 68090409 – MLC300T40-900 – Safety light curtain transmitter

	Part no.	Designation	Article	Description
	50133860	KD S-M12-5A-P1-050	Connection cable	Connection 1: Connector, M12, Axial, Female, A-coded, 5 -pin Connection 2: Open end Shielded: Yes Cable length: 5,000 mm Sheathing material: PUR
	50133861	KD S-M12-5A-P1-100	Connection cable	Connection 1: Connector, M12, Axial, Female, A-coded, 5 -pin Connection 2: Open end Shielded: Yes Cable length: 10,000 mm Sheathing material: PUR
	50137013	KD S-M12-5A-P1-500	Connection cable	Connection 1: Connector, M12, Axial, Female, A-coded, 5 -pin Connection 2: Open end Shielded: Yes Cable length: 10,000 mm Sheathing material: PVC
	50133841	KD U-M12-5A-P1-050	Connection cable	Connection 1: Connector, M12, Axial, Female, A-coded, 5 -pin Connection 2: Open end Shielded: No Cable length: 5,000 mm Sheathing material: PUR
	50132534	KD U-M12-5A-P1-100	Connection cable	Connection 1: Connector, M12, Axial, Female, A-coded, 5 -pin Connection 2: Open end Shielded: No Cable length: 10,000 mm Sheathing material: PUR

Connection technology - Connectors



	Part no.	Designation	Article	Description
	429175	CB-M12-5GF	Connector	Connection: Connector, M12, Axial, Female, A-coded, 5 -pin

Mounting technology - Mounting brackets







	Part no.	Designation	Article	Description
	429056	BT-2L	Mounting bracket set	Design of mounting device: Angle, L-shape Mounting bracket, at system: Through-hole mounting Mounting bracket, at device: Screw type Material: Metal
	429057	BT-2Z	Mounting bracket set	Design of mounting device: Angle, Z-shape Mounting bracket, at system: Through-hole mounting Mounting bracket, at device: Screw type Material: Metal

Part no.: 68090409 – MLC300T40-900 – Safety light curtain transmitter

Mounting technology - Swivel mounts

	Part no.	Designation	Article	Description
	429393	BT-2HF	Mounting bracket set	Contains: 2x BT-HF swivel mount, 1 cylinder for mounting on the light curtain Mounting bracket, at system: Through-hole mounting Mounting bracket, at device: Clampable Type of mounting device: Turning, 360° Material: Metal, Plastic
	429394	BT-2HF-S	Mounting bracket set	Contains: 2x BT-HF swivel mount, 1 cylinder for mounting on the light curtain Mounting bracket, at system: Through-hole mounting Mounting bracket, at device: Clampable Type of mounting device: Turning, 360° Material: Metal, Plastic Shock absorber: Yes

Mounting technology - Other



	Part no.	Designation	Article	Description
	425740	BT-10NC60	Sliding block set	Contains: 10x BT-NC sliding block Bore hole 1: Ø 4.7 mm Bore hole 2: M6 Design of mounting device: Sliding block Mounting bracket, at system: Mounting thread Mounting bracket, at device: Groove mounting Material: Metal
	425741	BT-10NC64	Sliding block set	Contains: 10x BT-NC-M4-M6 sliding block Bore hole 1: M4 Bore hole 2: M6 Design of mounting device: Sliding block Mounting bracket, at system: Mounting thread Mounting bracket, at device: Groove mounting Material: Metal
	425742	BT-10NC65	Sliding block set	Contains: 10x BT-NC-M5-M6 sliding block Bore hole 1: M5 Bore hole 2: M6 Design of mounting device: Sliding block Mounting bracket, at system: Mounting thread Mounting bracket, at device: Groove mounting Material: Metal
	424417	BT-2P40	Mounting bracket set	Contains: 2x BT-P40 clamp bracket Design of mounting device: Mounting clamp Mounting bracket, at system: Groove mounting Mounting bracket, at device: Groove mounting Type of mounting device: Clampable Material: Metal
	424422	BT-2SB10	Mounting bracket set	Contains: 2x BT-SB10 Design of mounting device: Mounting clamp Mounting bracket, at system: Through-hole mounting Mounting bracket, at device: Clampable, an der seitlichen C-Nut Type of mounting device: Swiveling Swivel range: -8 ... 8 ° Material: Metal
	424423	BT-2SB10-S	Mounting bracket set	Contains: 2x BT-SB10-S Design of mounting device: Mounting clamp Mounting bracket, at system: Through-hole mounting Mounting bracket, at device: Clampable, an der seitlichen C-Nut Swivel range: -8 ... 8 ° Material: Metal Shock absorber: Yes

Part no.: 68090409 – MLC300T40-900 – Safety light curtain transmitter

Alignment aids

	Part no.	Designation	Article	Description
	427300	AC-ALM	Alignment aid	Housing material: Plastic
	520101	AC-ALM-M	Alignment aid	Housing material: Plastic
	560020	LA-78U	Alignment aid	Light source: laser, Red Housing material: Metal
	520004	LA-78UDC	Alignment aid	Light source: laser, Red Housing material: Metal

Protective screens

	Part no.	Designation	Article	Description
	429038	MLC-2PSF	Mounting bracket set	Type of fastening: Clampable Mounting device material: Metal
	347076	MLC-PS900	Protective screen	Protective field height: 900 mm Material: PMMA, clear

Deflecting mirror

	Part no.	Designation	Article	Description
	529609	UM60-900	Deflecting mirror	Dimensions: 25 mm x 970 mm x 68 mm Protected field height up to: 900 mm Mirror length: 960 mm

Device columns

	Part no.	Designation	Article	Description
	549852	UDC-1300-S2	Device column	Dimensions: 160 mm x 1,360 mm x 149 mm Column height without foot: 1,300 mm Functions: Mounting and protection of light curtains and multiple light beam devices, Adjustable, 3 directions
	549853	UDC-1600-S2	Device column	Dimensions: 160 mm x 1,660 mm x 149 mm Column height without foot: 1,600 mm Functions: Mounting and protection of light curtains and multiple light beam devices, Adjustable, 3 directions
	549854	UDC-1900-S2	Device column	Dimensions: 160 mm x 1,960 mm x 149 mm Column height without foot: 1,900 mm Functions: Mounting and protection of light curtains and multiple light beam devices, Adjustable, 3 directions
	549867	UDC-2100-S2	Device column	Dimensions: 160 mm x 2,160 mm x 149 mm Column height without foot: 2,100 mm Functions: Adjustable, 3 directions, Mounting and protection of light curtains and multiple light beam devices
	549857	UDC-2500-S2	Device column	Dimensions: 160 mm x 2,560 mm x 149 mm Column height without foot: 2,500 mm Functions: Adjustable, 3 directions, Mounting and protection of light curtains and multiple light beam devices
	549865	UDC-3100-S2	Device column	Dimensions: 160 mm x 3,160 mm x 149 mm Column height without foot: 3,100 mm Functions: Mounting and protection of light curtains and multiple light beam devices, Adjustable, 3 directions

Notes

Observe intended use!

- The product may only be put into operation by competent persons.
- Only use the product in accordance with its intended use.